

**^ZIMUT**

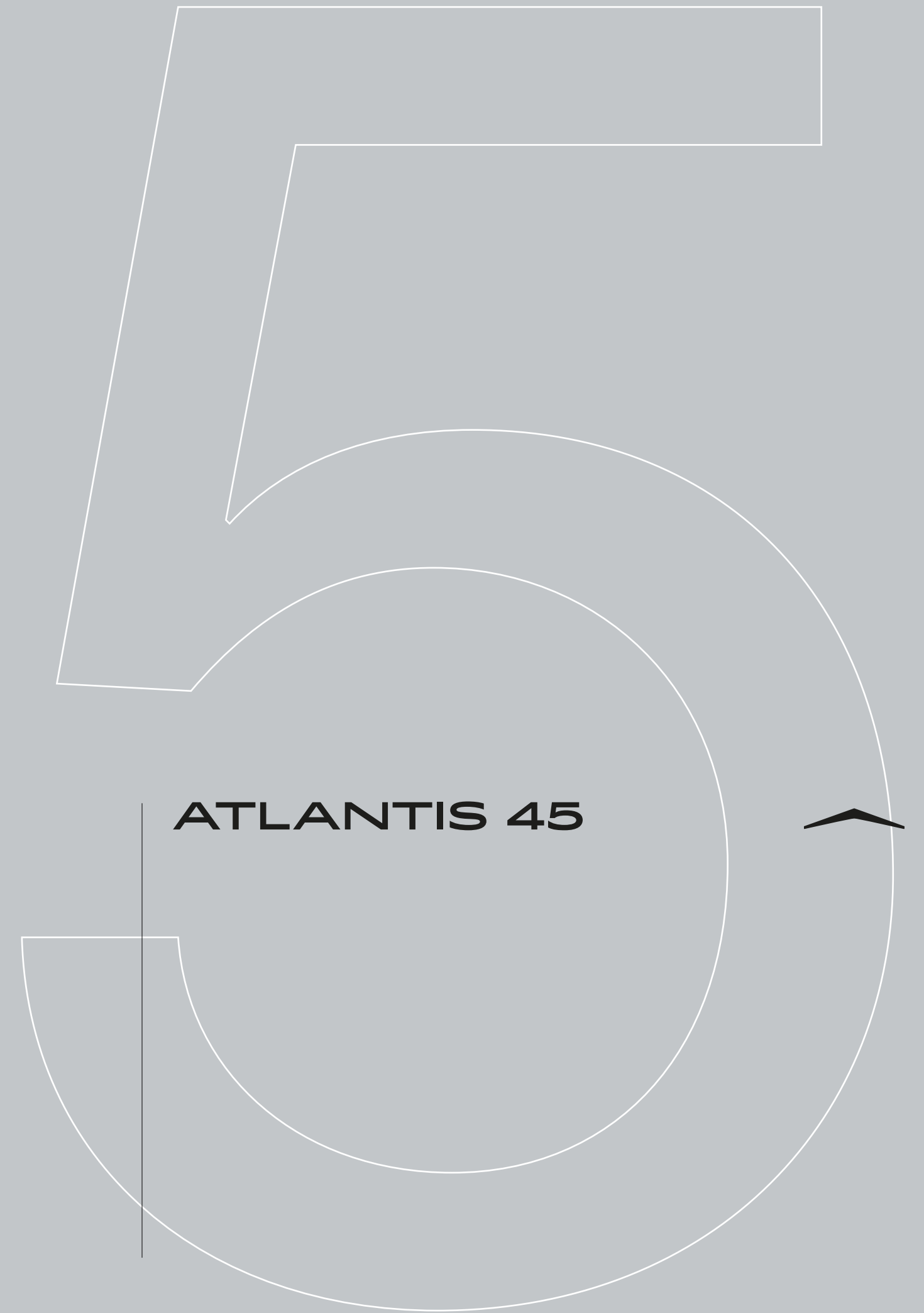

# INDEX

01	THE DESIGN & LIFESTYLE ON BOARD	P04
02	ATLANTIS 45 SPEC SHEET	P23
03	THE ATLANTIS SERIES	P27
04	ABOUT AZIMUT	P29



A one-of-a-kind beauty, enrapturing, that steals your breath away, leaving you speechless. An extraordinary idea as the only possible pathway, to get to where you want, to explore, to go beyond.

The freedom of embracing the unknown, that you know you'll love as a part of your very own story. A thought that provokes your mind and then inspires you to aim for the impossible, making mistakes, yet being brave.

A magic je ne sais quoi that enchants and intrigues you, moving you to feel more and to sense uniqueness.

The choice to risk it all, the one that makes you go for it, to impress yourself and all those who are worth it.

Welcome to Azimut.

AZIMUT.  
DARE TO AMAZE.

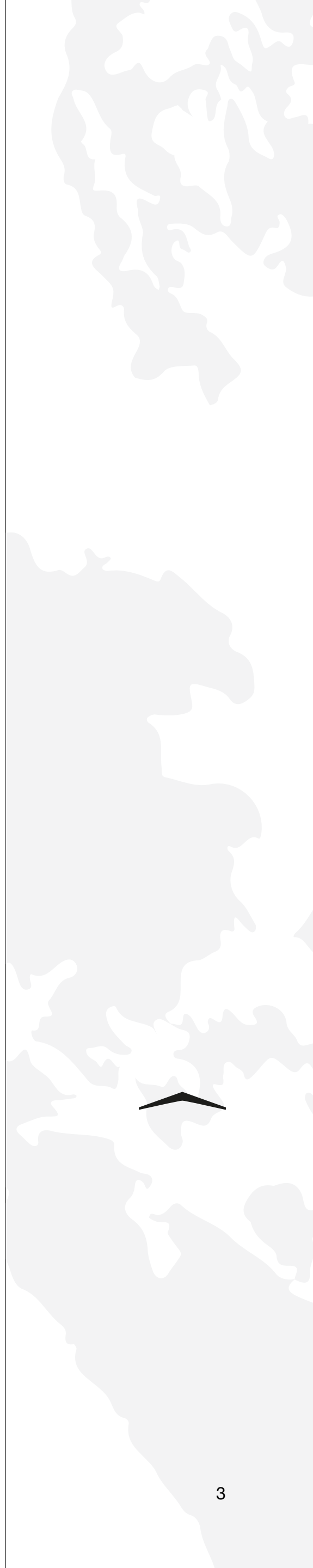



01

# THE DESIGN & LIFESTYLE ON BOARD



# ATLANTIS 45, A HIGH-CLASS SPORTING SPIRIT

Athletic splendor with a chic design appeal, the Atlantis 45 is optimized for peak performance, top comfort and effortless elegance.

Well-organized living spaces create a liberating dynamic on the main deck, while spacious interiors evoke an airy, lively mood. Versatile design adaptations cater to diverse lifestyle demands, as the contrasting synergy of materials, from matte to glossy details, inspires a neat sense of style.

Free your spirit on the Atlantis 45.









Welcome aboard, ladies and gentlemen.

Let us begin the tour.







# AT ONE WITH SEA AND SKY





The Atlantis 45 is a pure coupe, despite the class-leading living areas. The volumes are disguised by long, sleek lines across the profile. With a mastery of both proportion and stance, Atlantis 45 appears both quick and graceful, an impression proven true by the experience at the helm.



# OPEN AIR FREEDOM



The bow and stern are spotted with sunbeds, made of advanced materials. The choice of Batyline fabric and Dryfill padding combines luxuriously natural sensations with easy care.





[ The unusual size of the single-piece curved windscreen improves visibility, interior perception of space and exterior aesthetics. Interior windows pillars are minimized to extend the effect. ]



# A SEA-IMMERSIVE EXPERIENCE

The garage is topped by a sunbathing pad for two, making more room for catching rays within the cockpit social area.





# ROOFLESS RELAXATION



The expandable al fresco dining table is embraced by sofas, sharing a backrest with the helm and adjacent sun lounger.







[ A configurable chaise lounge sits beside the helm station with a protected, comfortable front-row view to navigation, keeping the pilot company. ]

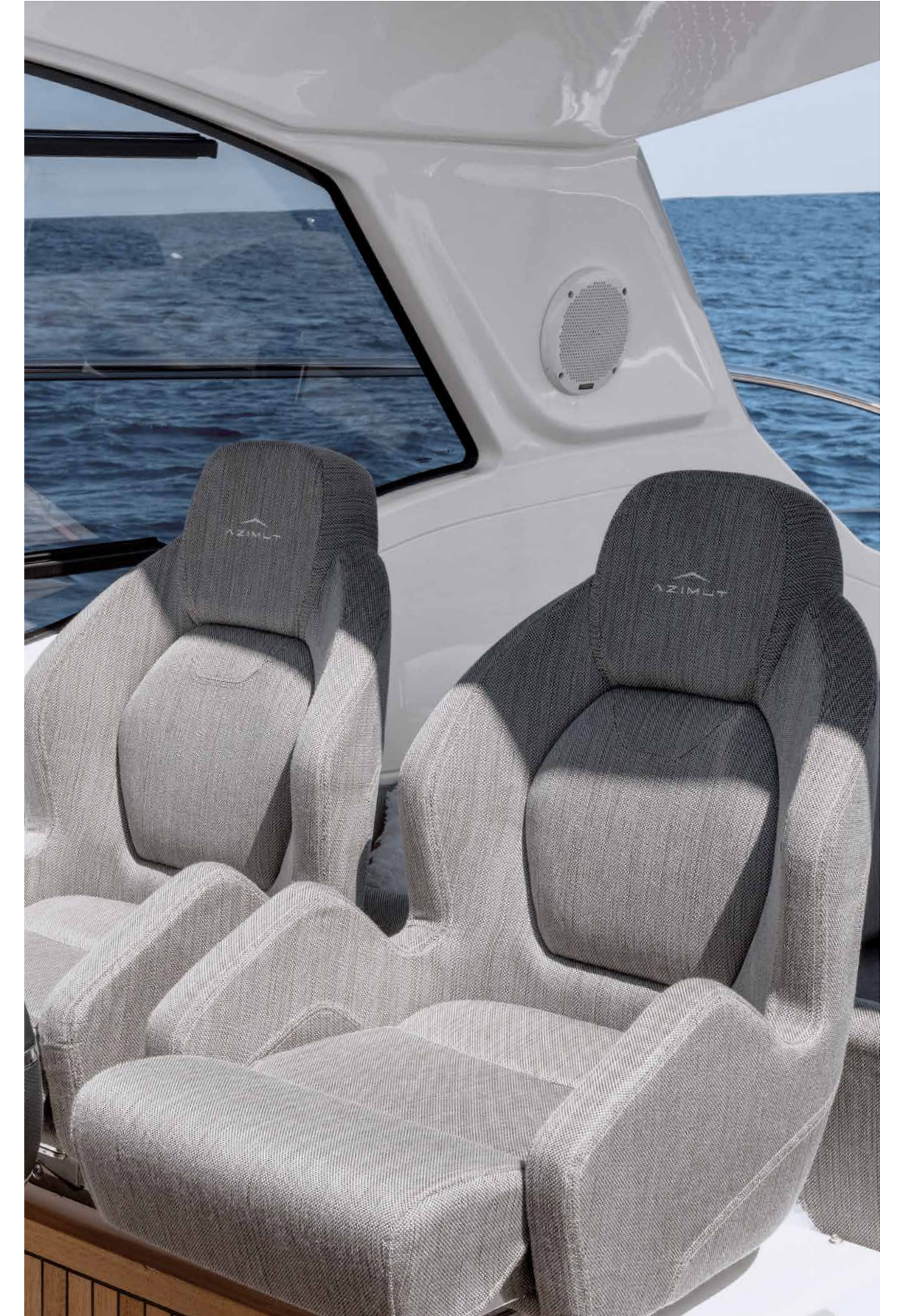





The experience at the helm is one of complete control, with a suite of intuitive tools at the pilot's fingertips. The uninterrupted front windshield means a clear view forward, adding to the excellent visibility out the elongated side windows and open aft.



Now, let us discover the guest accommodations.

Shall we?









# BEL AIR BELOW DECK

The airy lower deck living area is the alignment of two essential stations, the dinette lounge and the galley. The layout sets them almost opposite, opening up common space in the square room.







[ The forward master suite enjoys long hullside windows, full-height walking room and an en-suite bathroom. ]





[ A generous beam accommodates the versatile second cabin. The side cabinet can also be configured as a third bed while the twin single beds can slide together to form a queen-sized bed. ]











02

# ATLANTIS 45

# SPEC SHEET

# GENERAL CHARACTERISTICS

LENGTH OVERALL	14,61 m	47' 11"
BEAM MAX	4,20 m	13' 9"
DRAFT	1,1 m	3' 7"
DISPLACEMENT	16,6 t	36,596 lb
ENGINES	2 x Volvo D6 IPS 650-480 hp (353 kW)	
MAXIMUM SPEED	up to 35 kn	
CRUISING SPEED	30 kn	
KEEL	Planing, deadrise 15° aft	
FUEL CAPACITY	1000 l	264 US Gls
WATER CAPACITY	350 l	93 US Gls
CABINS	2	
BERTHS	4	
HEAD COMPARTMENTS	2	
BUILDING MATERIAL	GRP	
EXTERIOR DESIGNER	Neo Design	
INTERIOR DESIGNER	Azimut Yachts	
HULL DESIGNER	Azimut Benetti R&D Department	
BUILDER	Azimut Yachts	
CERTIFICATIONS	CE B; NMMA	

Last updated 08.2022  
Please consult your dealer for the latest specifications.

#### UNI ISO 8666

The performance described applies to a vessel with standard configuration (standard equipment installed) and a clean hull, propellers, and rudder. It is also noted that the performance described was recorded under favourable sea and wind conditions (Beaufort scale index 1, Douglas scale index 1); different and worse sea conditions could significantly impact performance.

#### CE MARK

Given the continual evolution of technology, Azimut | Benetti S.p.A reserves the right to modify the technical specifications on its vessels at any time and without prior notice.

# MAIN DECK

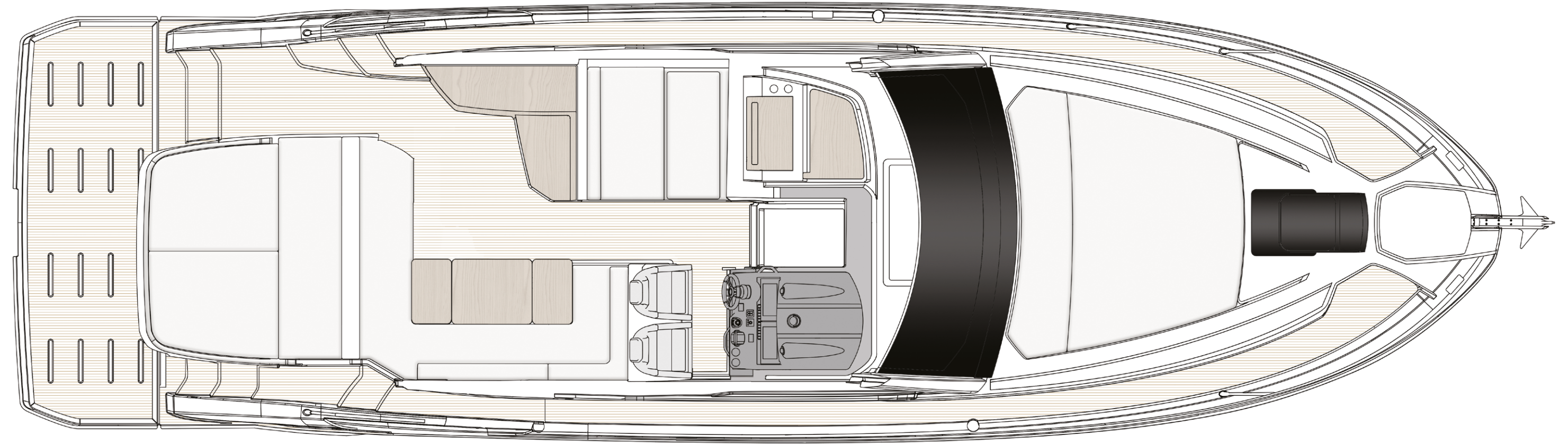

# LOWER DECK

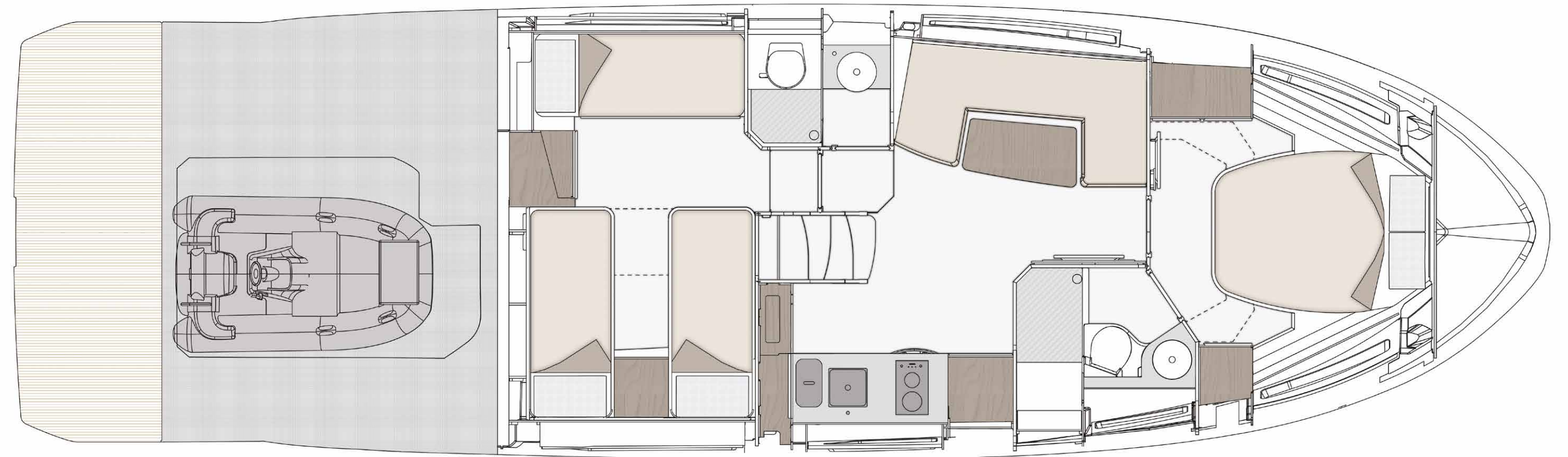





03

# THE ATLANTIS SERIES

# A THRILLING NAUTICAL NARRATIVE

The Azimut Atlantis Series unlocks a thrilling nautical narrative through the athletic aesthetics and genetics of a versatile sportive cruiser. Its personality designed for performance meets with technical finesse, allowing for ease of navigation while balancing beauty, safety and full functionality. Generous Italian-made interiors tailor to elegant tastes, opening up to the recreational possibilities of an indulgent but dynamic life at sea. Marvel at the harmony of sport and sublimity.

45  
51







04

# ABOUT AZIMUT



# A FAMILY-MADE COMPANY CULTURE

An immense and personal passion for the sea. A clear and forward-facing attitude. A strong and relentless work ethic. Since 1969, Paolo Vitelli, the creative visionary founder and businessman behind Azimut, has been set on challenging the industry's status quo with a daring desire: bring to life an unexpected nautical experience, through yachts built to combine alluring aesthetics with construction expertise and impeccable technology.

An audacious mindset that has, over time, surprised and captivated the yachting sector, transforming Azimut into a bold and recognizable benchmark, and laying the foundation for the birth of the largest megayacht builder in the world, the Azimut | Benetti Group.

The international and management-based standing of the company today, is deeply nourished by the solid and memorable family heritage that has distinguished it from the beginning. A historically pioneering vision that enables it to continue thriving day after day, through ingenious inventions and long-term goals that look to the future with Paolo's daughter, Giovanna Vitelli.



# A SUSTAINABLE VISION TODAY, FOR TOMORROW

An avant-garde vision and a strong emotional appeal have shaped the history of Azimut as a leader in the field of nautical innovation as well as its commitment to the creation of a sustainable-oriented and attentive company culture today.

An ambitious and personal touch that has allowed Azimut to grow and evolve on both levels, embracing the challenge of a future nurtured by an eco-conscious approach to boat construction and by an authentic focus and responsibility on human well-being.







# OUR ♻️ ECO-YACHTING PHILOSOPHY

The Azimut I Benetti Group has made tangible investments to guide the Technical as well as the R&D departments toward the construction of yachts with a diminished environmental impact. Its main areas of intervention have focused on significantly lowering fuel consumption and CO2 emissions through the development of highly efficient hull designs, innovative propulsion systems and an extensive use of carbon fiber to decrease yacht weight.





# A SAFE AND HEALTHY WORK ENVIRONMENT

The forerunning shipyard of Avigliana was the first of the company's Italian shipyards to obtain the ISO 45001 certification in 2011, attesting its rigorous abidance to all occupational health and safety requirements. Recognized as the most technologically-advanced shipyard in Europe, it has also led the nautical sector revolution in terms of being among the earliest adopters of the vacuum infusion process to drive resin into a laminate, avoiding styrene emissions and therefore guaranteeing its precious workers a healthier setting.

As of 2013, all the other Italian production sites have adapted to meet the necessary requirements to obtain the ISO 45001 certification.







# A GLOBALLY-CONNECTED DEALER AND SERVICE NETWORK

---

5 SHIPYARDS

---

6 DIRECT OFFICES

---

138 OFFICIAL DEALERS

---

80 COUNTRIES

---

The highly widespread commercial network put in place by Azimut Yachts, allows the company to offer a continuous presence to its ship owners, concretely curating their demands by meeting their most specific needs.

[Find your Dealer →](#)





# THE LARGEST PRIVATE GROUP IN THE YACHTING WORLD

Azimut is part of the Azimut | Benetti Group, the biggest private player and shipbuilder in the nautical sector today. The Vitelli family, the founder and majority shareholder of the company, has been leading the way for over fifty years now, continuing to innovate through the Group's main yacht brands, Azimut and Benetti, while developing a variety of service brands to cater to the different demands of ship owners worldwide.





# OUR SHIPYARDS MAKE US PROUD

Avigliana — Italy

HQ / SHIPYARD

Savona — Italy

DELIVERY CENTRE

Viareggio — Italy

SHIPYARD / STYLING LOUNGE

Fano — Italy

SHIPYARD

Itajaí — Brazil

SHIPYARD

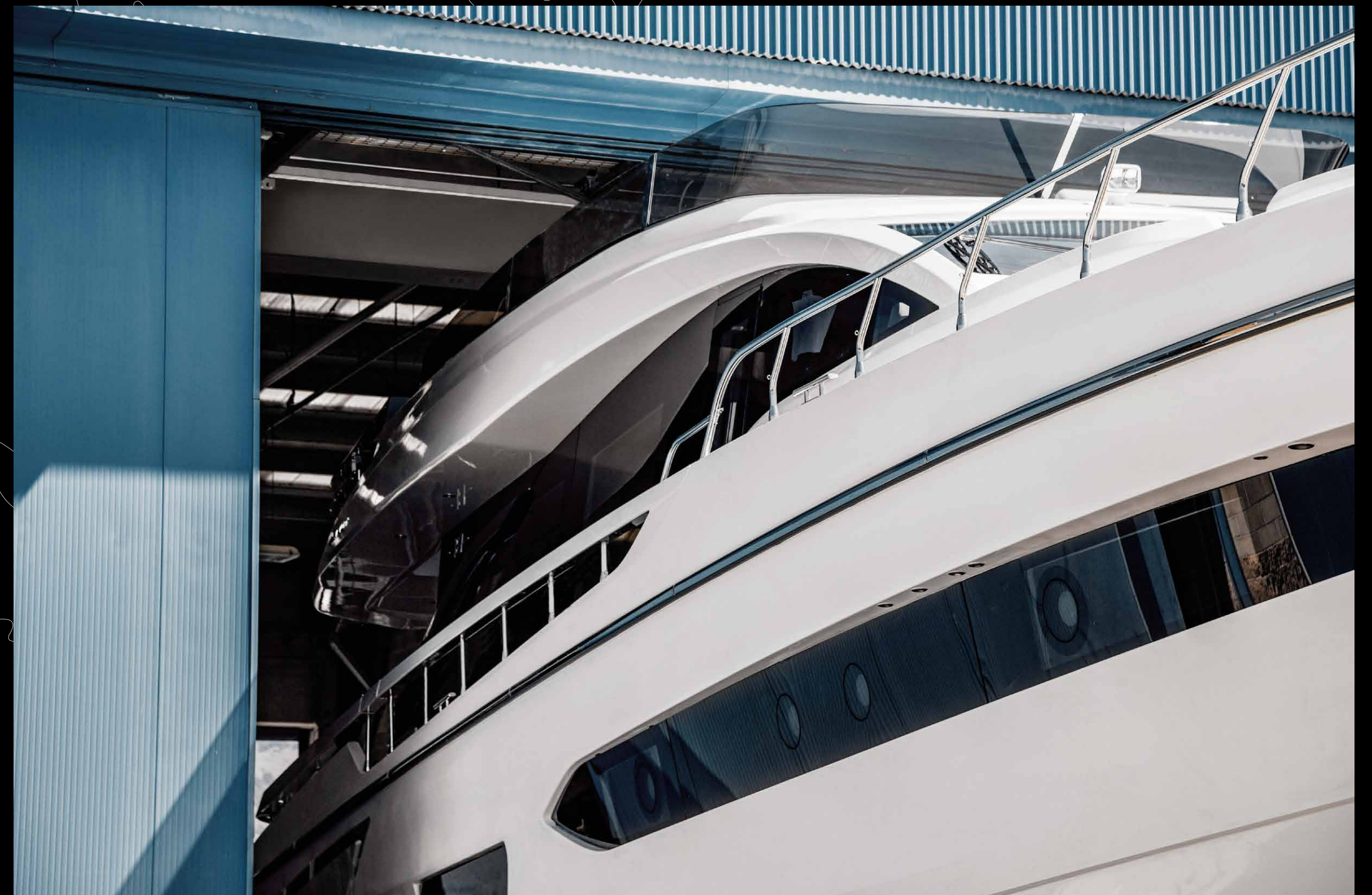





CONCEPT & DESIGN: APART  
PHOTOS: ALESSANDRO GUERRIERI, SARA MAGNI

AZIMUT YACHTS THANKS: APR LUXURY LINEN, CASAMANCE,  
DEDAR, FRETTE, LA TAVOLA, MARIAFLORA, MARIO LUCA GIUSTI,  
TOM DIXON.

OFFICIAL PARTNERS



GARMIN.

NAVICO  
GROUP

Raymarine

SEAKEEPER

VOLVO  
PENTA

AZIMUT | BENETTI SPA  
VIA MARTIN LUTHER KING, 9  
10051 AVIGLIANA, TORINO  
ITALY

RELEASE 01.24

This brochure in no way constitutes a contract of sale for the boatyard's vessels to any person or company. All information contained herein, including but not limited to technical and performance data, illustrations, and drawings, is non-binding and for purposes of illustration only. The information in this brochure refers to the boatyard's standard motoryacht models available as of the date of publication. Technical and descriptive information is valid only to the extent that it pertains to the specific vessel that is the subject of a purchase. Contract terms are valid only to the extent that they are contained in a contract of sale. This document is based on information available at the time of publication. Despite efforts to ensure the greatest possible accuracy, the information contained herein may fail to cover all details, omit technical or commercial changes that may have been made subsequent to publication, describe features that are not present, and fail to envisage all circumstances that might occur. Any illustrations, photographs, diagrams and examples shown in this brochure are included solely for the purposes of illustrating the text. Due to the different features of each vessel, the boatyard assumes no liability for actual use based on the illustrated applications.



AZIMUT

[azimutyachts.com](http://azimutyachts.com)

